



INSTALLATION INSTRUCTIONS

Accessory
REAR BUMPER APPLIQUE
P/N 08P48-TK6-100

Application
2010 FIT

Publications No.
All 42210
Issue Date
AUG 2009

PARTS LIST

Rear bumper applique

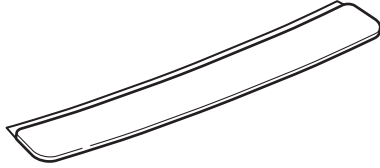

Soft sleeve

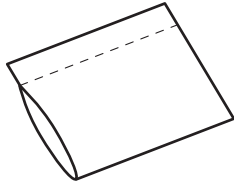

Applicator

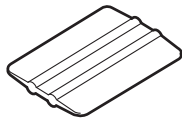

Alcohol swab

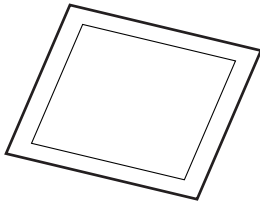

INSTALLATION

NOTE:

- Be careful not to damage the rear bumper and other finished surfaces of the body.
- This kit should only be installed if the ambient air temperature is above 15°C (60°F) or above.
- To allow the adhesive to cure, do not wash the vehicle for 24 hours.

1. Using the alcohol swab, clean the rear bumper where the rear bumper applique will attach.

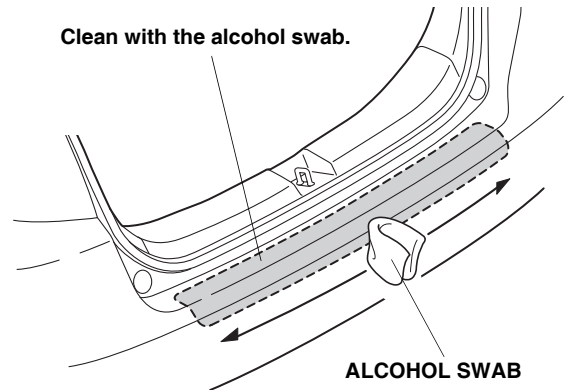

2. Remove the center adhesive backing from the rear bumper applique.

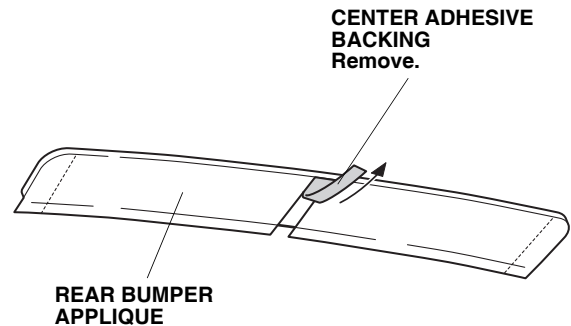

- Place the rear bumper applique on the rear bumper, and align the cutout with the tailgate latch anchor as shown.

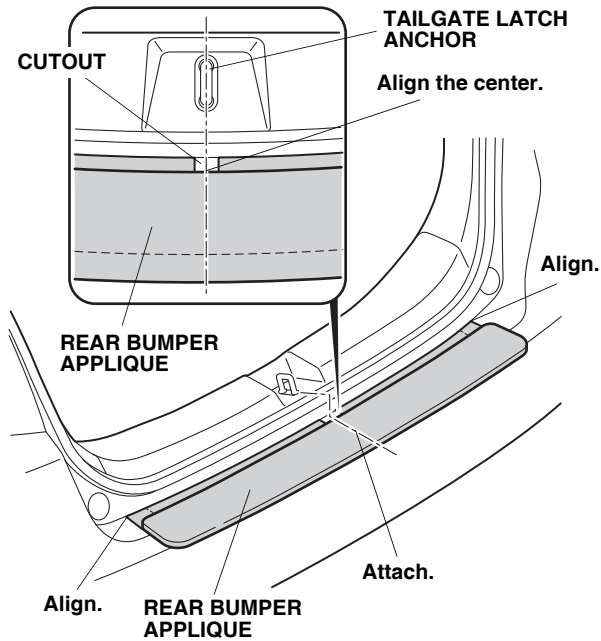

- Attach the center of the rear bumper applique to the rear bumper.
- Starting from the center, remove the adhesive backing. Using the soft sleeve and applicator, firmly press the top section of the rear bumper applique against the rear bumper.

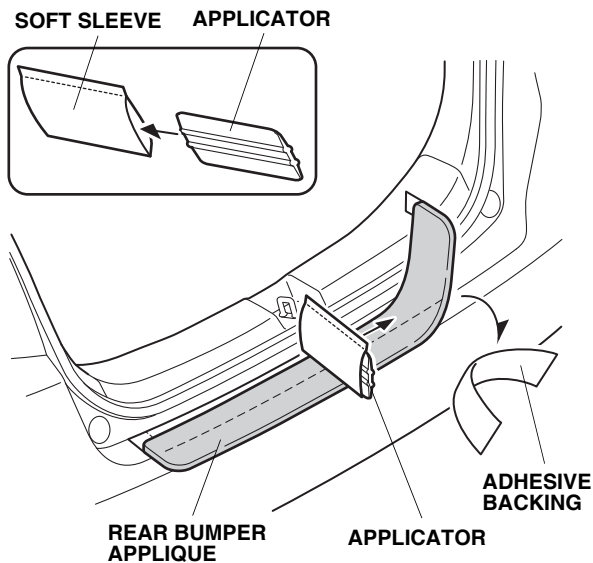

- Remove the adhesive backing, and firmly press the rear bumper applique against the rear bumper.

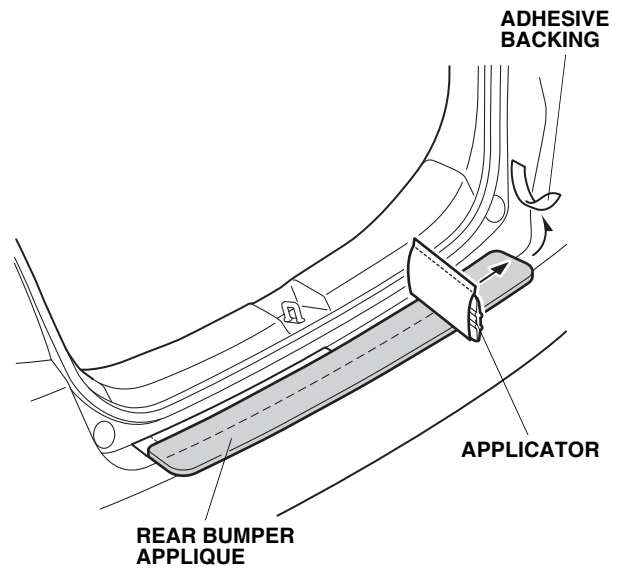

- Repeat steps 5 and 6 on the other side.
- Once the top section is finished with no bubbles, rub the applicator along the round edge. Start in the middle and work outwards in small sections working down. Rub the applicator across and down around the bumper 3 to 4 times to prevent air bubbles. Attach the rear bumper applique to the other side the same way.

